

CMOS Quad 2-Input NAND Schmitt Triggers

High-Voltage Types (20 Volt Rating)

■ CD4093B consists of four Schmitt-trigger circuits. Each circuit functions as a two-input NAND gate with Schmitt-trigger action on both inputs. The gate switches at different points for positive- and negative-going signals. The difference between the positive voltage (V_P) and the negative voltage (V_N) is defined as hysteresis voltage (V_H) (see Fig. 2).

The CD4093B types are supplied in 14-lead hermetic dual-in-line ceramic packages (F3A suffix), 14-lead dual-in-line plastic packages (E suffix), 14-lead small-outline packages (M, MT, M96, and NSR suffixes), and 14-lead thin shrink small-outline packages (PW and PWR suffixes).

Features:

- Schmitt-trigger action on each input with no external components
- Hysteresis voltage typically 0.9 V at $V_{DD} = 5\text{ V}$ and 2.3 V at $V_{DD} = 10\text{ V}$
- Noise immunity greater than 50%
- No limit on input rise and fall times
- Standardized, symmetrical output characteristics
- 100% tested for quiescent current at 20 V
- Maximum input current of 1 μA at 18 V over full package-temperature range, 100 nA at 18 V and 25°C
- 5-V, 10-V, and 15-V parametric ratings
- Meets all requirements of JEDEC Standard No. 13B, "Standard Specifications for Description of 'B' Series CMOS Devices"

Applications:

- Wave and pulse shapers
- High-noise-environment systems
- Monostable multivibrators
- Astable multivibrators
- NAND logic



RECOMMENDED OPERATING CONDITIONS

For maximum reliability, nominal operating conditions should be selected so that operation is always within the following ranges.

CHARACTERISTIC	MIN.	MAX.	UNITS
Supply Voltage Range ($T_A = \text{Full Package Temp. Range}$)	3	18	V

MAXIMUM RATINGS, Absolute-Maximum Values:

DC SUPPLY-VOLTAGE RANGE, (V_{DD})	
Voltages referenced to V_{SS} Terminal	–0.5V to +20V
INPUT VOLTAGE RANGE, ALL INPUTS	–0.5V to $V_{DD} + 0.5\text{ V}$
DC INPUT CURRENT, ANY ONE INPUT	$\pm 10\text{ mA}$
PACKAGE THERMAL IMPEDANCE, θ_{JA} (See Note 1):	
E package	80°C/W
M package	86°C/W
NS package	76°C/W
DEVICE DISSIPATION PER OUTPUT TRANSISTOR	
FOR $T_A = \text{FULL PACKAGE-TEMPERATURE RANGE}$ (All Package Types)	100mW
OPERATING-TEMPERATURE RANGE (T_A)	–55°C to +125°C
STORAGE TEMPERATURE RANGE (T_{stg})	–65°C to +150°C
LEAD TEMPERATURE (DURING SOLDERING):	
At distance 1/16 \pm 1/32 inch (1.59 \pm 0.79mm) from case for 10s max	+265°C

NOTE 1: Package thermal impedance is calculated in accordance with JESD 51-7.



* ALL INPUTS PROTECTED BY CMOS PROTECTION NETWORK

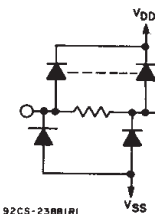

Fig. 1 – Logic diagram—1 of 4 Schmitt triggers.

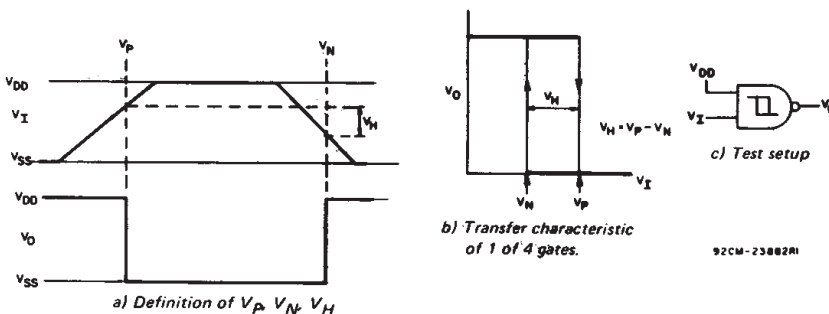

Fig. 2 – Hysteresis definition, characteristic, and test setup.

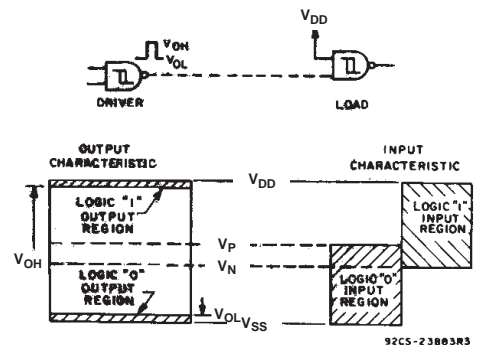

Fig. 3 – Input and output characteristics.

CD4093B Types

STATIC ELECTRICAL CHARACTERISTICS

CHARACTERISTIC	CONDITIONS			LIMITS AT INDICATED TEMPERATURES (°C)							UNITS
	V _O (V)	V _{IN} (V)	V _{DD} (V)	-55	-40	+85	+125	+25			
								MIN.	TYP.	MAX.	
Quiescent Device Current, I _{DD} Max.	-	0.5	5	1	1	30	30	-	0.02	1	μA
	-	0.10	10	2	2	60	60	-	0.02	2	
	-	0.15	15	4	4	120	120	-	0.02	4	
	-	0.20	20	20	20	600	600	-	0.04	20	
Positive Trigger Threshold Voltage V _p Min.	-	a	5	2.2	2.2	2.2	2.2	2.2	2.9	-	V
	-	a	10	4.6	4.6	4.6	4.6	4.6	5.9	-	
	-	a	15	6.8	6.8	6.8	6.8	6.8	8.8	-	
	-	b	5	2.6	2.6	2.6	2.6	2.6	3.3	-	
	-	b	10	5.6	5.6	5.6	5.6	5.6	7	-	
	-	b	15	6.3	6.3	6.3	6.3	6.3	9.4	-	
V _p Max.	-	a	5	3.6	3.6	3.6	3.6	-	2.9	3.6	V
	-	a	10	7.1	7.1	7.1	7.1	-	5.9	7.1	
	-	a	15	10.8	10.8	10.8	10.8	-	8.8	10.8	
	-	b	5	4	4	4	4	-	3.3	4	
	-	b	10	8.2	8.2	8.2	8.2	-	7	8.2	
	-	b	15	12.7	12.7	12.7	12.7	-	9.4	12.7	
Negative Trigger Threshold Voltage V _N Min.	-	a	5	0.9	0.9	0.9	0.9	0.9	1.9	-	V
	-	a	10	2.5	2.5	2.5	2.5	2.5	3.9	-	
	-	a	15	4	4	4	4	4	5.8	-	
	-	b	5	1.4	1.4	1.4	1.4	1.4	2.3	-	
	-	b	10	3.4	3.4	3.4	3.4	3.4	5.1	-	
	-	b	15	4.8	4.8	4.8	4.8	4.8	7.3	-	
V _N Max.	-	a	5	2.8	2.8	2.8	2.8	-	1.9	2.8	V
	-	a	10	5.2	5.2	5.2	5.2	-	3.9	5.2	
	-	a	15	7.4	7.4	7.4	7.4	-	5.8	7.4	
	-	b	5	3.2	3.2	3.2	3.2	-	2.3	3.2	
	-	b	10	6.6	6.6	6.6	6.6	-	5.1	6.6	
	-	b	15	9.6	9.6	9.6	9.6	-	7.3	9.6	
Hysteresis Voltage V _H Min.	-	a	5	0.3	0.3	0.3	0.3	0.3	0.9	-	V
	-	a	10	1.2	1.2	1.2	1.2	1.2	2.3	-	
	-	a	15	1.6	1.6	1.6	1.6	1.6	3.5	-	
	-	b	5	0.3	0.3	0.3	0.3	0.3	0.9	-	
	-	b	10	1.2	1.2	1.2	1.2	1.2	2.3	-	
	-	b	15	1.6	1.6	1.6	1.6	1.6	3.5	-	
V _H Max.	-	a	5	1.6	1.6	1.6	1.6	-	0.9	1.6	V
	-	a	10	3.4	3.4	3.4	3.4	-	2.3	3.4	
	-	a	15	5	5	5	5	-	3.5	5	
	-	b	5	1.6	1.6	1.6	1.6	-	0.9	1.6	
	-	b	10	3.4	3.4	3.4	3.4	-	2.3	3.4	
	-	b	15	5	5	5	5	-	3.5	5	

^a Input on terminals 1,5,8,12 or 2,6,9,13; other inputs to V_{DD}.

^b Input on terminals 1 and 2, 5 and 6, 8 and 9, or 12 and 13; other inputs to V_{DD}.

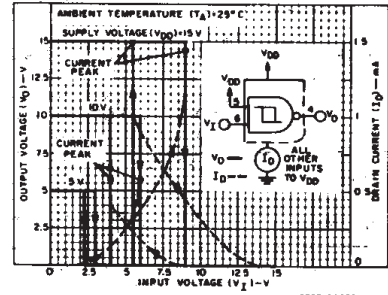

Fig. 4 - Typical current and voltage transfer characteristics.

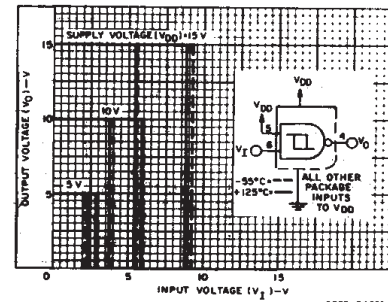

Fig. 5 - Typical voltage transfer characteristics as a function of temperature.

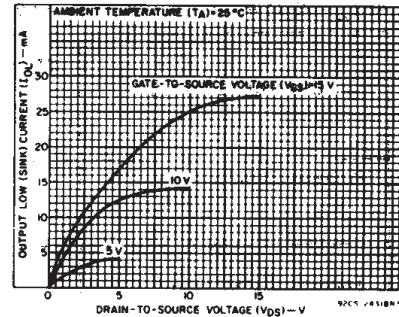

Fig. 6 - Typical output low (sink) current characteristics.

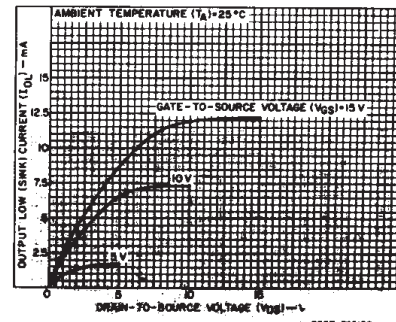

Fig. 7 - Minimum output low (sink) current characteristics.

CD4093B Types

STATIC ELECTRICAL CHARACTERISTICS (CONT'D)

CHARACTERISTIC	CONDITIONS			LIMITS AT INDICATED TEMPERATURES (°C)							UNITS
	V _O (V)	V _{IN} (V)	V _{DD} (V)	-55	-40	+85	+125	+25			
								MIN.	TYP.	MAX.	
Output Low (Sink) Current, I _{OL} Min.	0.4	0.5	5	0.64	0.61	0.42	0.36	0.51	1	—	mA
	0.5	0.10	10	1.6	1.5	1.1	0.9	1.3	2.6	—	
	1.5	0.15	15	4.2	4	2.8	2.4	3.4	6.8	—	
Output High (Source) Current, I _{OH} Min.	4.6	0.5	5	-0.64	-0.61	-0.42	-0.36	-0.51	-1	—	mA
	2.5	0.5	5	-2	-1.8	-1.3	-1.15	-1.6	-3.2	—	
	9.5	0.10	10	-1.6	-1.5	-1.1	-0.9	-1.3	-2.6	—	
	13.5	0.15	15	-4.2	-4	-2.8	-2.4	-3.4	-6.8	—	
Output Voltage Low-Level, V _{OL} Max.	—	0.5	5	0.05				—	0	0.05	V
	—	0.10	10	0.05				—	0	0.05	
	—	0.15	15	0.05				—	0	0.05	
Output Voltage High-Level, V _{OH} Min.	—	0.5	5	4.95				4.95	5	—	V
	—	0.10	10	9.95				9.95	10	—	
	—	0.15	15	14.95				14.95	—	—	
Input Current, I _{IN} Max.	—	0.18	18	±0.1	±0.1	±1	±1	—	±10 ⁻⁵	±0.1	μA

DYNAMIC ELECTRICAL CHARACTERISTICS

At T_A = 25°C; Input t_r, t_f = 20 ns, C_L = 50 pF, R_L = 200kΩ

CHARACTERISTIC	TEST CONDITIONS	LIMITS			UNITS
		V _{DD} VOLTS	TYP.	MAX.	
Propagation Delay Time: t _{PHL} t _{PLH}		5	190	380	ns
		10	90	180	
		15	65	130	
Transition Time, t _{THL} t _{TLH}		5	100	200	ns
		10	50	100	
		15	40	80	
Input Capacitance, C _{IN}	Any Input		5	7.5	pF

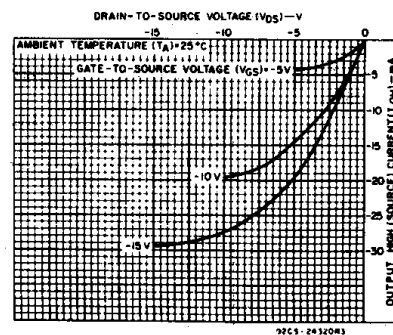

Fig. 8 – Typical output high (source) current characteristics.

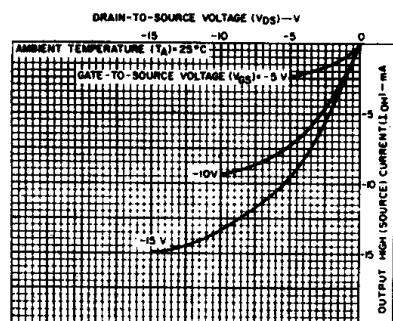

Fig. 9 – Minimum output high (source) current characteristics.

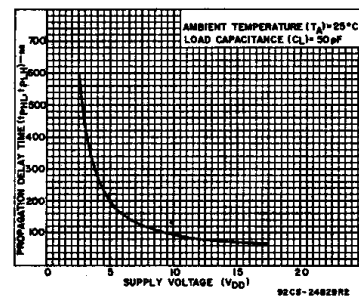

Fig. 10 – Typical propagation delay time vs. supply voltage.

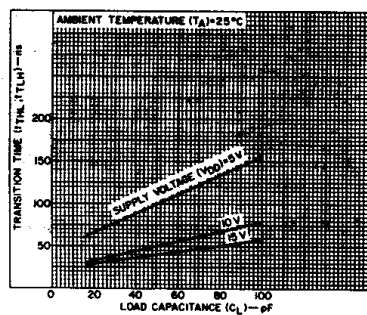

Fig. 11 – Typical transition time vs. load capacitance.

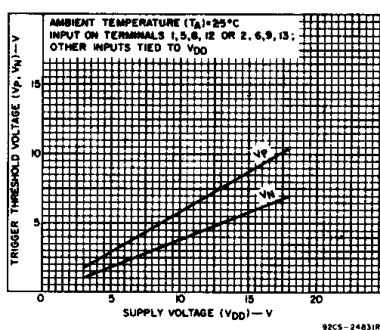

Fig. 12 – Typical trigger threshold voltage vs. V_{DD}

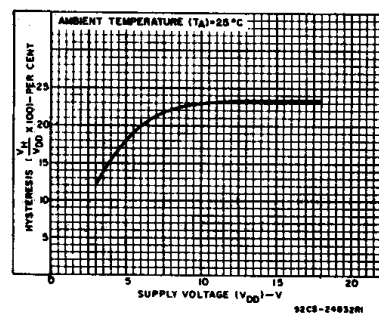

Fig. 13 – Typical per cent hysteresis vs. supply voltage.

CD4093B Types



Fig. 14 - Typical power dissipation vs. frequency characteristics.

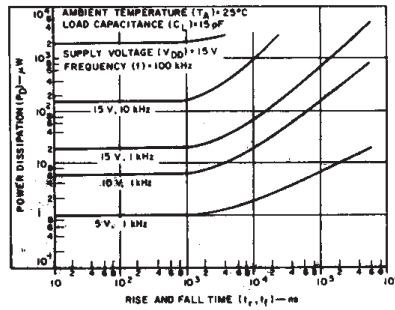

Fig. 15 - Typical power dissipation vs. rise and fall times.

APPLICATIONS



Fig. 16 - Wave shaper.



Fig. 17 - Monostable multivibrator.

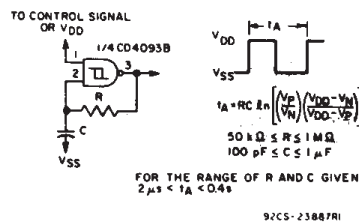

Fig. 18 - Astable multivibrator.

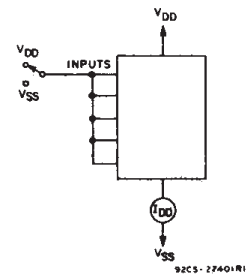

Fig. 19 - Quiescent device current test circuit.

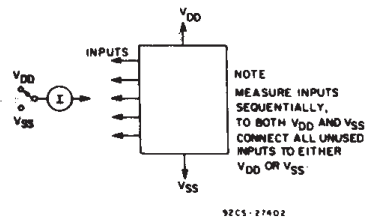
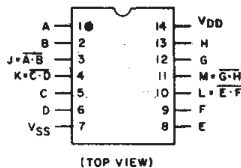

Fig. 20 - Input current test circuit.



TERMINAL ASSIGNMENT

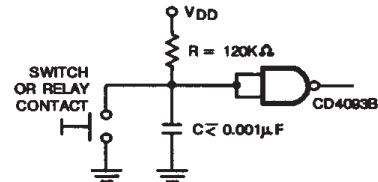

Fig. 21 - Contact Debouncer

PACKAGING INFORMATION

Orderable Device	Status ⁽¹⁾	Package Type	Package Drawing	Pins	Package Qty	Eco Plan ⁽²⁾	Lead/Ball Finish	MSL Peak Temp ⁽³⁾
7704602CA	ACTIVE	CDIP	J	14	1	TBD	Call TI	Level-NC-NC-NC
CD4093BE	ACTIVE	PDIP	N	14	25	Pb-Free (RoHS)	CU NIPDAU	Level-NC-NC-NC
CD4093BF	ACTIVE	CDIP	J	14	1	TBD	Call TI	Level-NC-NC-NC
CD4093BF3A	ACTIVE	CDIP	J	14	1	TBD	Call TI	Level-NC-NC-NC
CD4093BM	ACTIVE	SOIC	D	14	50	Pb-Free (RoHS)	CU NIPDAU	Level-2-260C-1 YEAR/ Level-1-235C-UNLIM
CD4093BM96	ACTIVE	SOIC	D	14	2500	Pb-Free (RoHS)	CU NIPDAU	Level-2-260C-1 YEAR/ Level-1-235C-UNLIM
CD4093BMT	ACTIVE	SOIC	D	14	250	Pb-Free (RoHS)	CU NIPDAU	Level-2-260C-1 YEAR/ Level-1-235C-UNLIM
CD4093BNSR	ACTIVE	SO	NS	14	2000	Pb-Free (RoHS)	CU NIPDAU	Level-2-260C-1 YEAR/ Level-1-235C-UNLIM
CD4093BPW	ACTIVE	TSSOP	PW	14	90	Pb-Free (RoHS)	CU NIPDAU	Level-1-250C-UNLIM
CD4093BPWR	ACTIVE	TSSOP	PW	14	2000	Pb-Free (RoHS)	CU NIPDAU	Level-1-250C-UNLIM

⁽¹⁾ The marketing status values are defined as follows:

ACTIVE: Product device recommended for new designs.

LIFEBUY: TI has announced that the device will be discontinued, and a lifetime-buy period is in effect.

NRND: Not recommended for new designs. Device is in production to support existing customers, but TI does not recommend using this part in a new design.

PREVIEW: Device has been announced but is not in production. Samples may or may not be available.

OBSOLETE: TI has discontinued the production of the device.

⁽²⁾ Eco Plan - The planned eco-friendly classification: Pb-Free (RoHS) or Green (RoHS & no Sb/Br) - please check <http://www.ti.com/productcontent> for the latest availability information and additional product content details.

TBD: The Pb-Free/Green conversion plan has not been defined.

Pb-Free (RoHS): TI's terms "Lead-Free" or "Pb-Free" mean semiconductor products that are compatible with the current RoHS requirements for all 6 substances, including the requirement that lead not exceed 0.1% by weight in homogeneous materials. Where designed to be soldered at high temperatures, TI Pb-Free products are suitable for use in specified lead-free processes.

Green (RoHS & no Sb/Br): TI defines "Green" to mean Pb-Free (RoHS compatible), and free of Bromine (Br) and Antimony (Sb) based flame retardants (Br or Sb do not exceed 0.1% by weight in homogeneous material)

⁽³⁾ MSL, Peak Temp. -- The Moisture Sensitivity Level rating according to the JEDEC industry standard classifications, and peak solder temperature.

Important Information and Disclaimer:The information provided on this page represents TI's knowledge and belief as of the date that it is provided. TI bases its knowledge and belief on information provided by third parties, and makes no representation or warranty as to the accuracy of such information. Efforts are underway to better integrate information from third parties. TI has taken and continues to take reasonable steps to provide representative and accurate information but may not have conducted destructive testing or chemical analysis on incoming materials and chemicals. TI and TI suppliers consider certain information to be proprietary, and thus CAS numbers and other limited information may not be available for release.

In no event shall TI's liability arising out of such information exceed the total purchase price of the TI part(s) at issue in this document sold by TI to Customer on an annual basis.

J (R-GDIP-T**)

14 LEADS SHOWN

CERAMIC DUAL IN-LINE PACKAGE



DIM \ PINS **	14	16	18	20
A	0.300 (7,62) BSC	0.300 (7,62) BSC	0.300 (7,62) BSC	0.300 (7,62) BSC
B MAX	0.785 (19,94)	.840 (21,34)	0.960 (24,38)	1.060 (26,92)
B MIN	—	—	—	—
C MAX	0.300 (7,62)	0.300 (7,62)	0.310 (7,87)	0.300 (7,62)
C MIN	0.245 (6,22)	0.245 (6,22)	0.220 (5,59)	0.245 (6,22)



4040083/F 03/03

- NOTES:
- All linear dimensions are in inches (millimeters).
 - This drawing is subject to change without notice.
 - This package is hermetically sealed with a ceramic lid using glass frit.
 - Index point is provided on cap for terminal identification only on press ceramic glass frit seal only.
 - Falls within MIL STD 1835 GDIP1-T14, GDIP1-T16, GDIP1-T18 and GDIP1-T20.

N (R-PDIP-T**)

PLASTIC DUAL-IN-LINE PACKAGE

16 PINS SHOWN



- NOTES:
- A. All linear dimensions are in inches (millimeters).
 - B. This drawing is subject to change without notice.
 - Falls within JEDEC MS-001, except 18 and 20 pin minimum body length (Dim A).
 - The 20 pin end lead shoulder width is a vendor option, either half or full width.

MECHANICAL DATA

NS (R-PDSO-G**)

PLASTIC SMALL-OUTLINE PACKAGE

14-PINS SHOWN



- NOTES:
- A. All linear dimensions are in millimeters.
 - B. This drawing is subject to change without notice.
 - C. Body dimensions do not include mold flash or protrusion, not to exceed 0,15.

PW (R-PDSO-G**)

PLASTIC SMALL-OUTLINE PACKAGE

14 PINS SHOWN



4040064/F 01/97

- NOTES: A. All linear dimensions are in millimeters.
 B. This drawing is subject to change without notice.
 C. Body dimensions do not include mold flash or protrusion not to exceed 0,15.
 D. Falls within JEDEC MO-153

IMPORTANT NOTICE

Texas Instruments Incorporated and its subsidiaries (TI) reserve the right to make corrections, modifications, enhancements, improvements, and other changes to its products and services at any time and to discontinue any product or service without notice. Customers should obtain the latest relevant information before placing orders and should verify that such information is current and complete. All products are sold subject to TI's terms and conditions of sale supplied at the time of order acknowledgment.

TI warrants performance of its hardware products to the specifications applicable at the time of sale in accordance with TI's standard warranty. Testing and other quality control techniques are used to the extent TI deems necessary to support this warranty. Except where mandated by government requirements, testing of all parameters of each product is not necessarily performed.

TI assumes no liability for applications assistance or customer product design. Customers are responsible for their products and applications using TI components. To minimize the risks associated with customer products and applications, customers should provide adequate design and operating safeguards.

TI does not warrant or represent that any license, either express or implied, is granted under any TI patent right, copyright, mask work right, or other TI intellectual property right relating to any combination, machine, or process in which TI products or services are used. Information published by TI regarding third-party products or services does not constitute a license from TI to use such products or services or a warranty or endorsement thereof. Use of such information may require a license from a third party under the patents or other intellectual property of the third party, or a license from TI under the patents or other intellectual property of TI.

Reproduction of information in TI data books or data sheets is permissible only if reproduction is without alteration and is accompanied by all associated warranties, conditions, limitations, and notices. Reproduction of this information with alteration is an unfair and deceptive business practice. TI is not responsible or liable for such altered documentation.

Resale of TI products or services with statements different from or beyond the parameters stated by TI for that product or service voids all express and any implied warranties for the associated TI product or service and is an unfair and deceptive business practice. TI is not responsible or liable for any such statements.

Following are URLs where you can obtain information on other Texas Instruments products and application solutions:

Products		Applications	
Amplifiers	amplifier.ti.com	Audio	www.ti.com/audio
Data Converters	dataconverter.ti.com	Automotive	www.ti.com/automotive
DSP	dsp.ti.com	Broadband	www.ti.com/broadband
Interface	interface.ti.com	Digital Control	www.ti.com/digitalcontrol
Logic	logic.ti.com	Military	www.ti.com/military
Power Mgmt	power.ti.com	Optical Networking	www.ti.com/opticalnetwork
Microcontrollers	microcontroller.ti.com	Security	www.ti.com/security
		Telephony	www.ti.com/telephony
		Video & Imaging	www.ti.com/video
		Wireless	www.ti.com/wireless

Mailing Address: Texas Instruments
Post Office Box 655303 Dallas, Texas 75265